

# Děkujeme za zakoupení produktu!

## DEN ZEMĚ

### DEMONSTRAČNÍ KARTY

Karty s ekologickým chováním

Karty se škodlivým chováním pro životní prostředí

### SMUTNÁ X VESELÁ PLANETA

Třídění dle toho, zda činnost na obrázku je prospěšná pro planetu či škodlivá.

### PŘÍŘAZOVACÍ KARTY

Jak se můžeme chovat ohleduplněji?

### DOBA ROZKLADU ODPADKŮ V PŘÍRODĚ

Přehledové karty a malé kartičky, které můžeme využít při tipování, za jak dlouho se věc rozloží. Např. vybereme dvě kartičky a dítě tipuje, co se rozloží dřív.

### TŘÍDÍCÍ KARTY

Sada 9 karet s kontejnery, kdy na každé kartě je 10 odpadků. Úkolem je označit 5 odpadků, které patří do daného kontejneru.

### CO SE DĚJE S VYTRŽIDĚNÝM ODPADEM?

Přehledové karty s popisem a karty na příkládání.

Např. rozbitá sklenice - zelený kontejner - láhev na nápoje

Materiál je určen pouze pro osobní použití  
nebo pro použití ve třídě.

Je zakázáno poskytovat, nahrávat či zasílat materiál ke sdílení  
dalším osobám nebo využívat ke komerčním účelům.

Děkujeme, že respektujete naši práci.

# Unoduo.cz

info@unoduo.cz

 unoduocz

 UnodDuo.cz

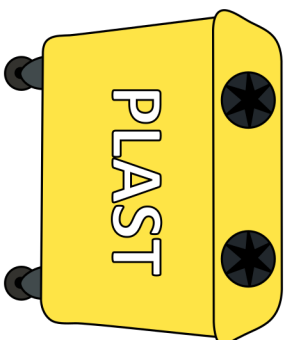
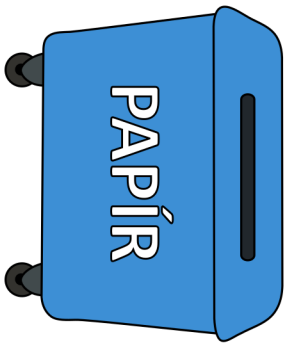

Třídíme odpad.

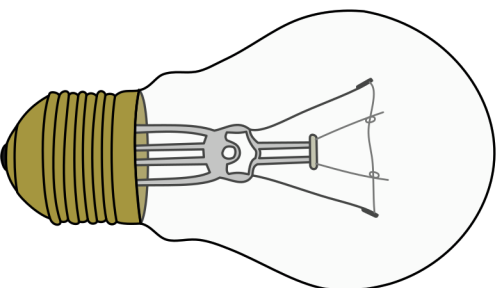

Šetříme elektrickou energii.

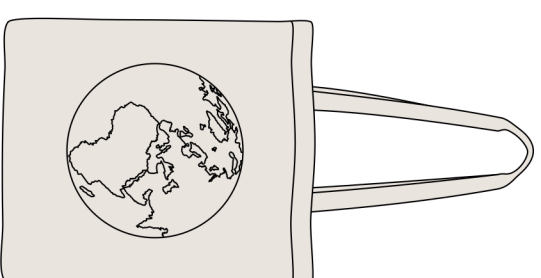

Používáme věci opakovaně.

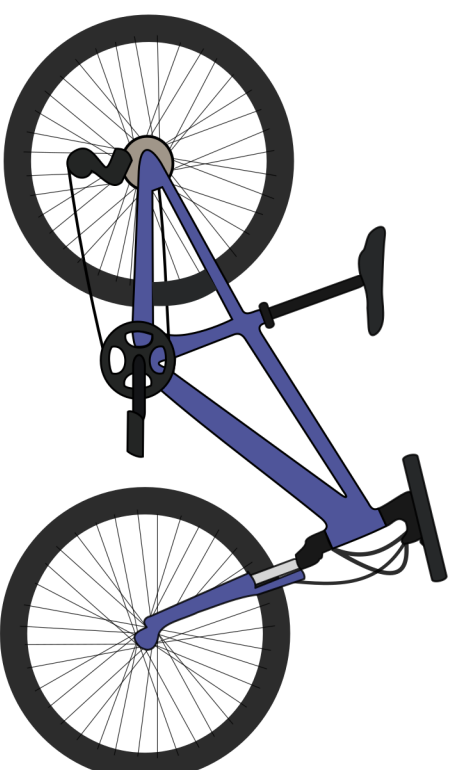

Chodíme pěšky nebo jezdíme na kole.

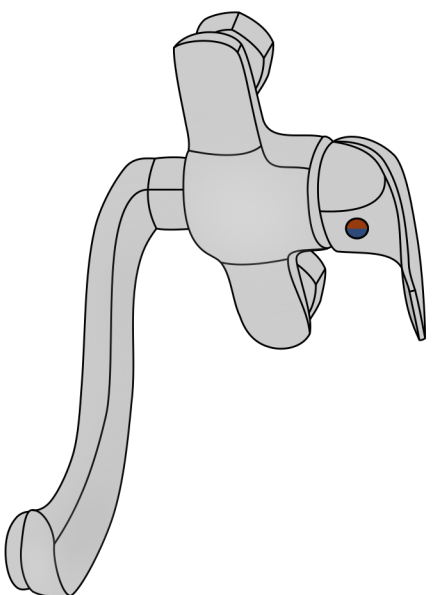

Šetříme vodou.

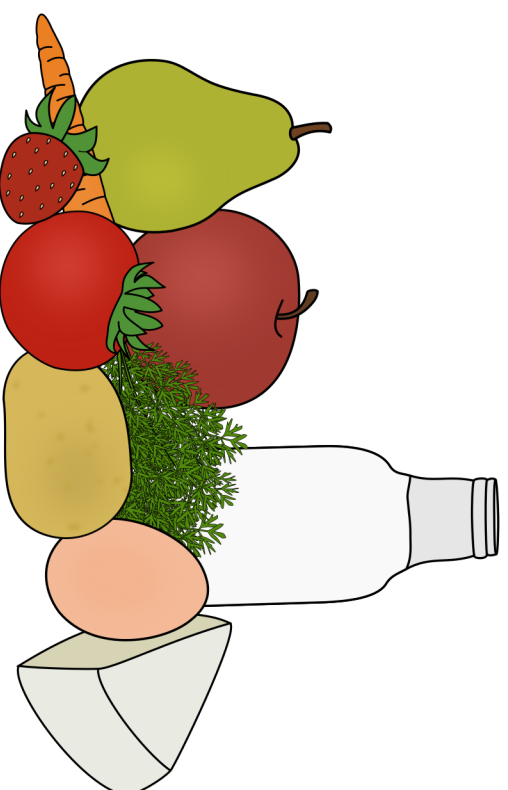

Nakupujeme lokální potraviny.

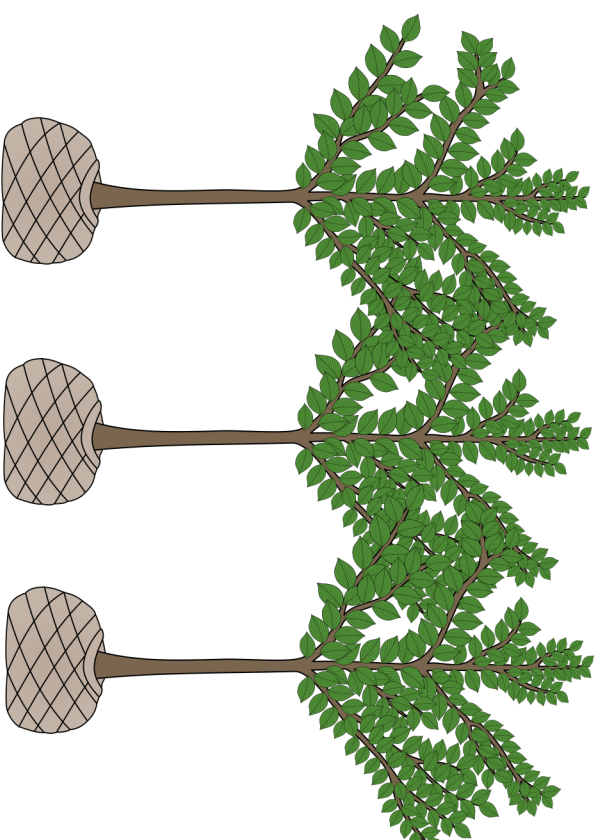

Vysazujeme nové stromy.

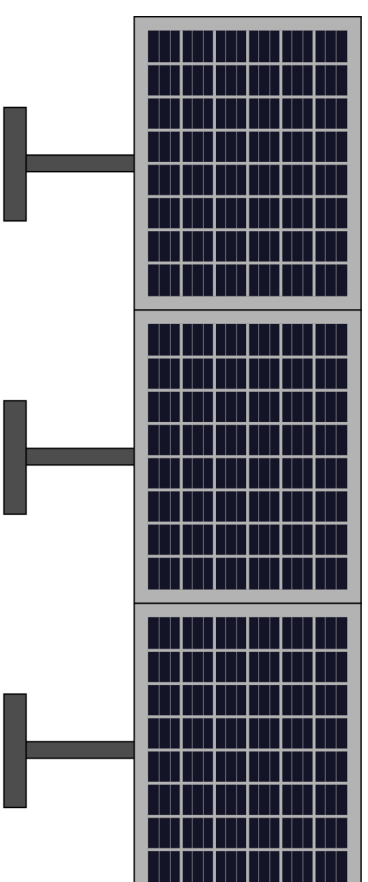

Využíváme solární energii.

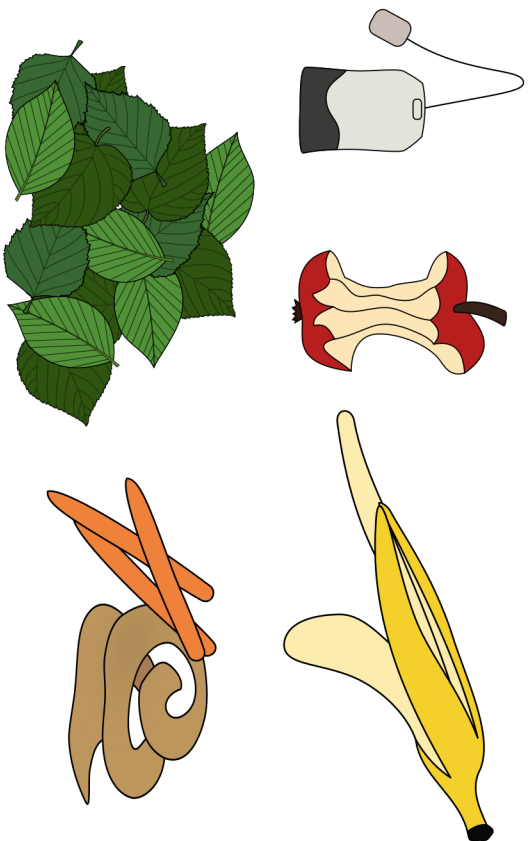

Kompostujeme biologický odpad.

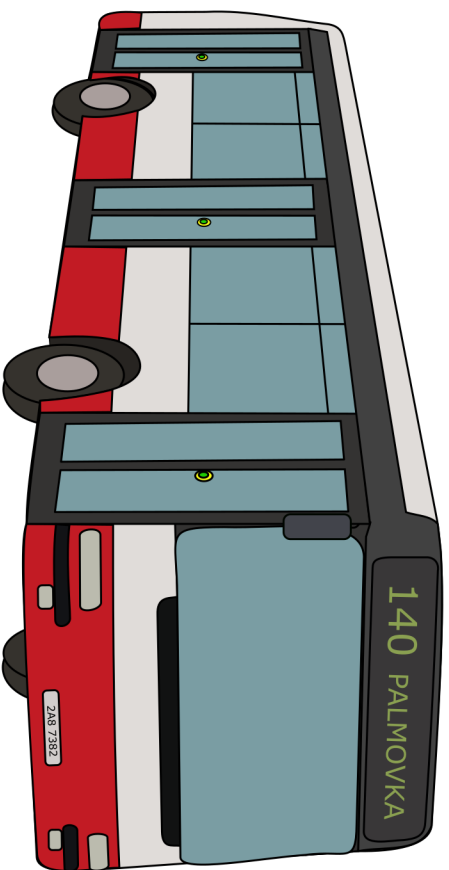

Na delší vzdálenosti využíváme hromadné dopravní prostředky.

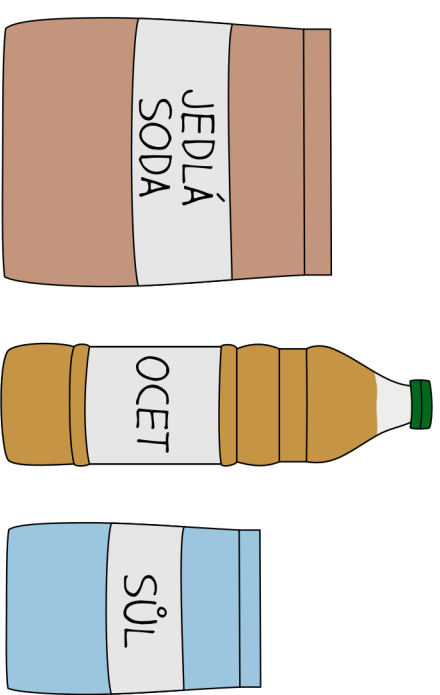

Používáme ekologické čisticí prostředky.

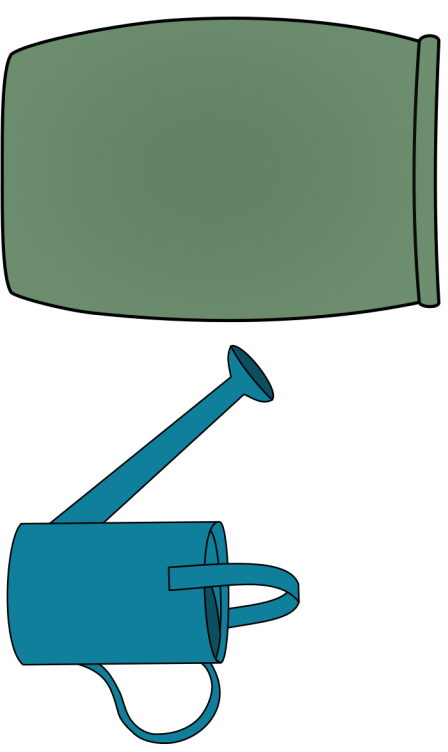

Využíváme dešťovou vodu.

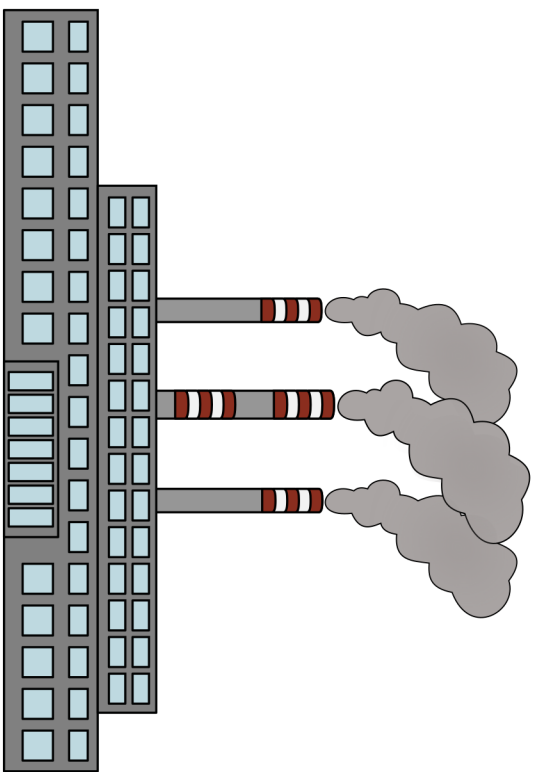

KOŮŘ Z TOVÁREN

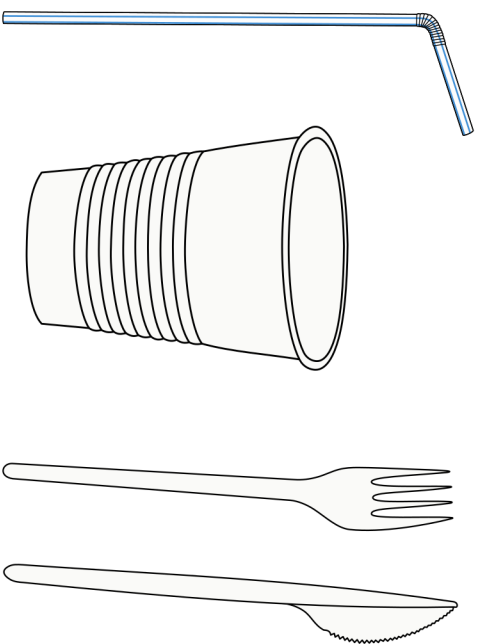

JEDNORÁZOVÉ PLASTY

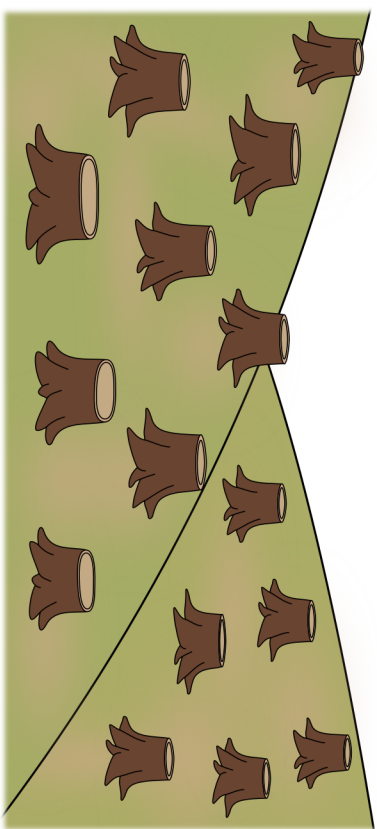

KÁCENÍ LESŮ A PRALESŮ

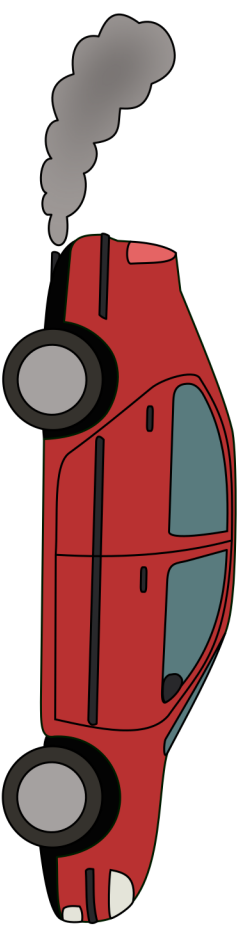

VÝFUKOVÉ PLYNY MOTOROVÝCH VOZIDEL

ZNEČIŠŤOVÁNÍ VODNÍCH TOKŮ

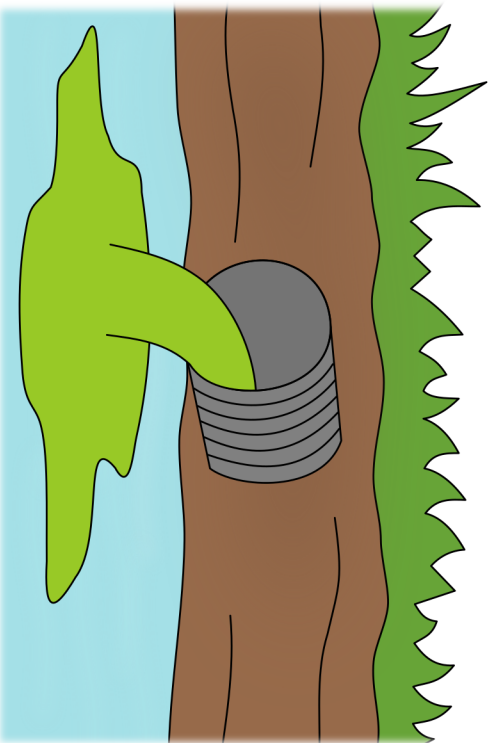

SKLÁDKA NETŘÍDĚNÉHO ODPADU



PLÝTVÁNÍ POTRAVINAMI

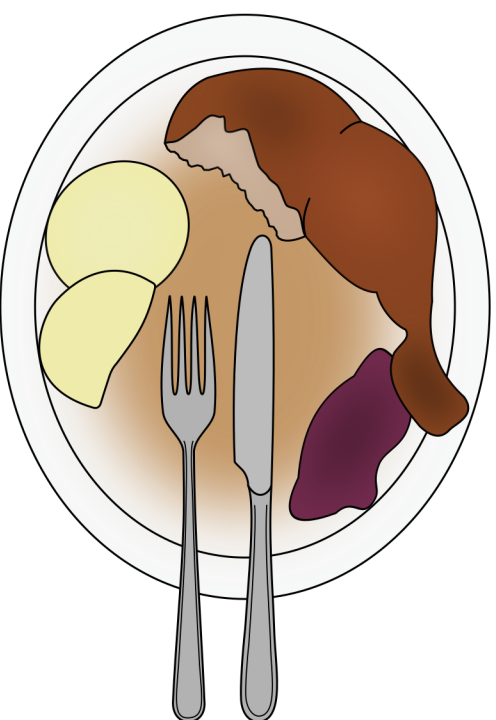

ODPADKY V PŘÍRODĚ

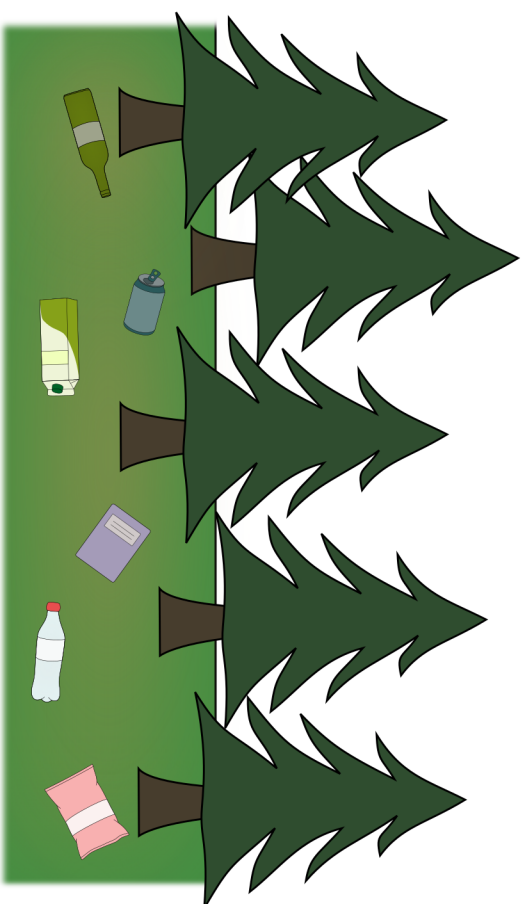



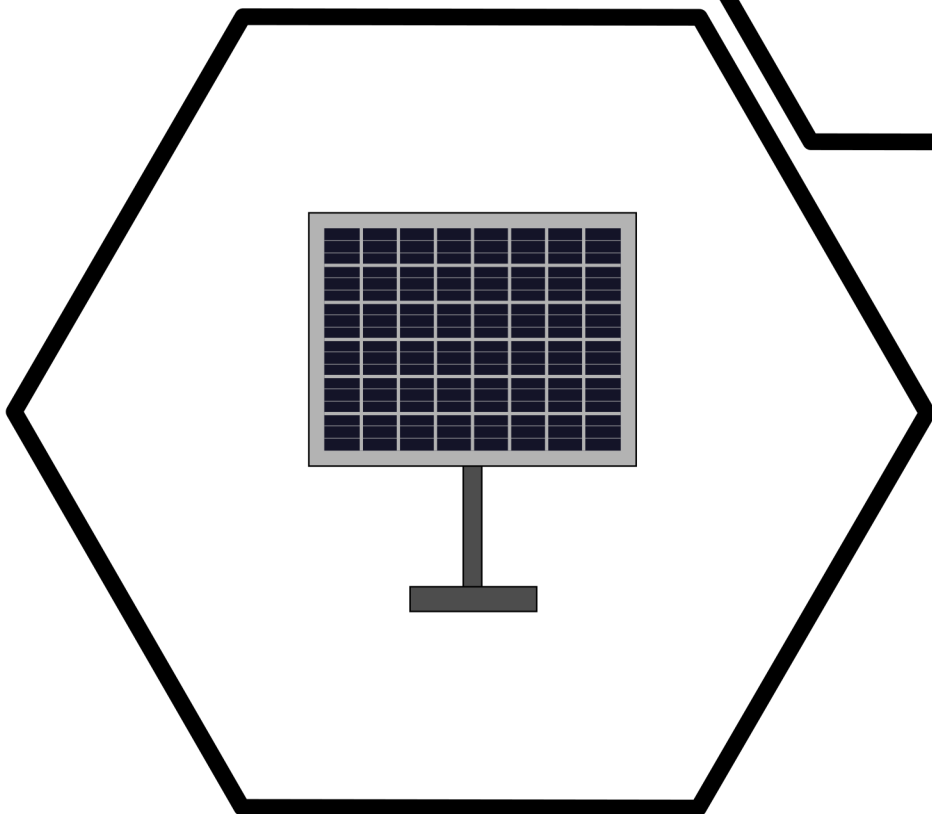
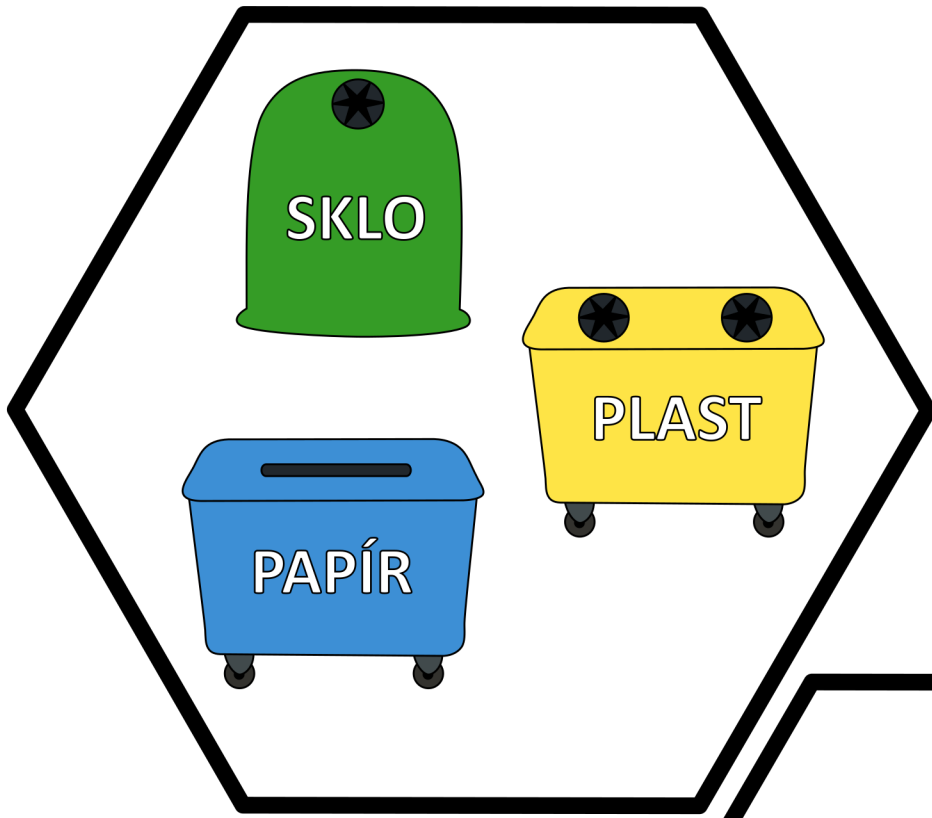



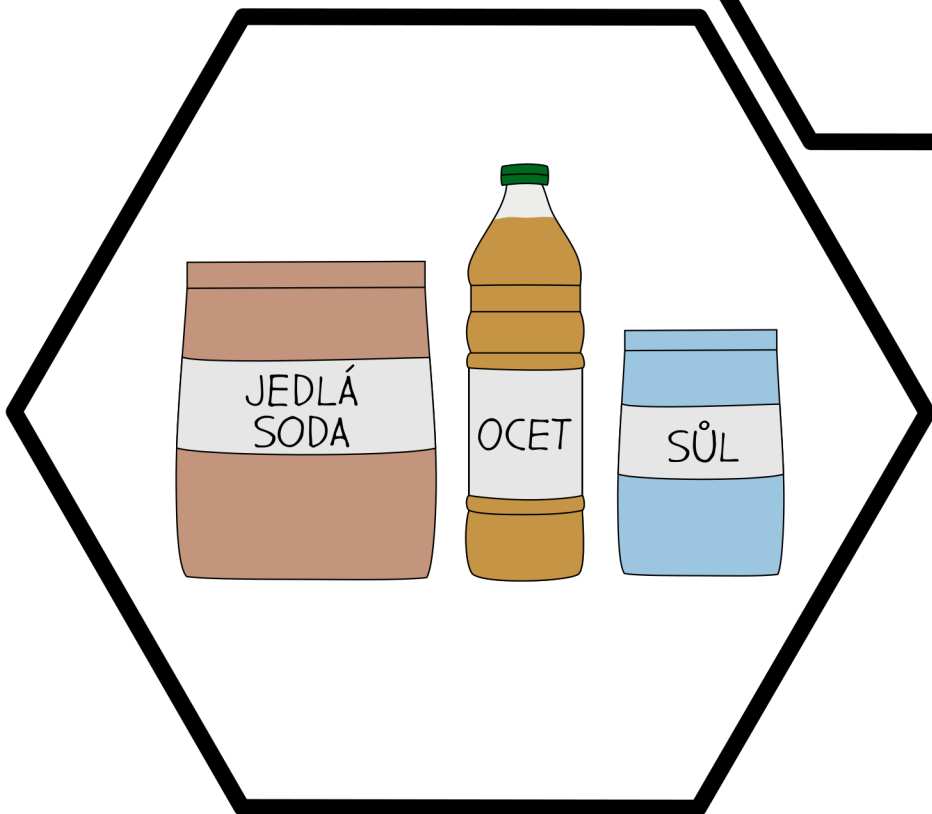
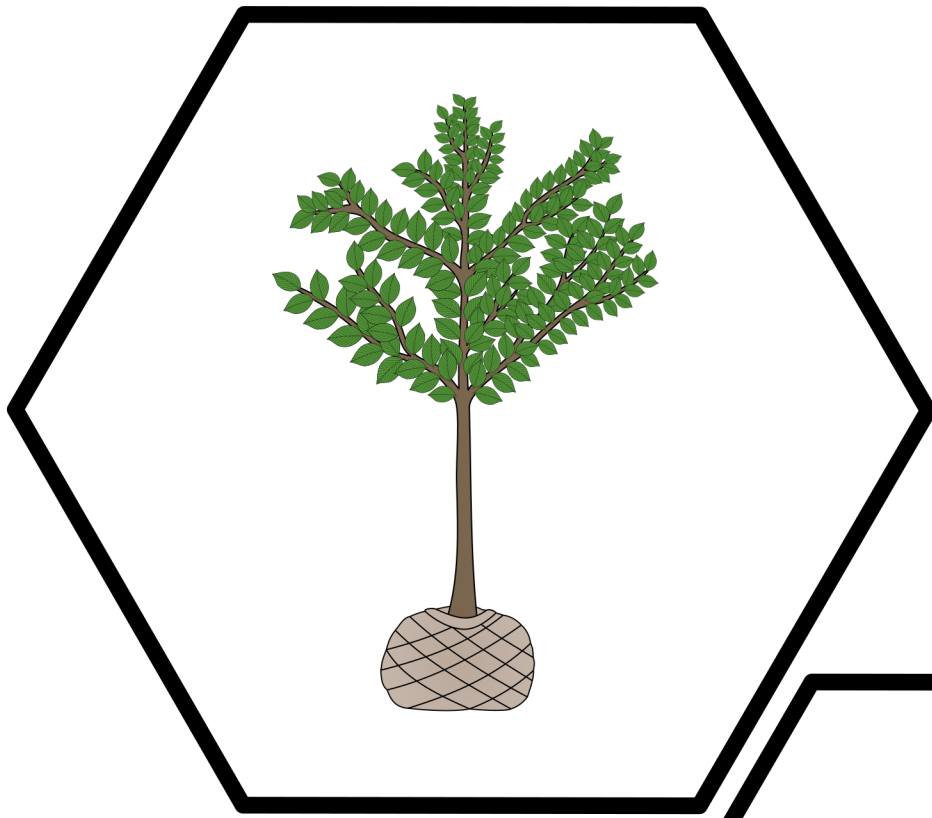

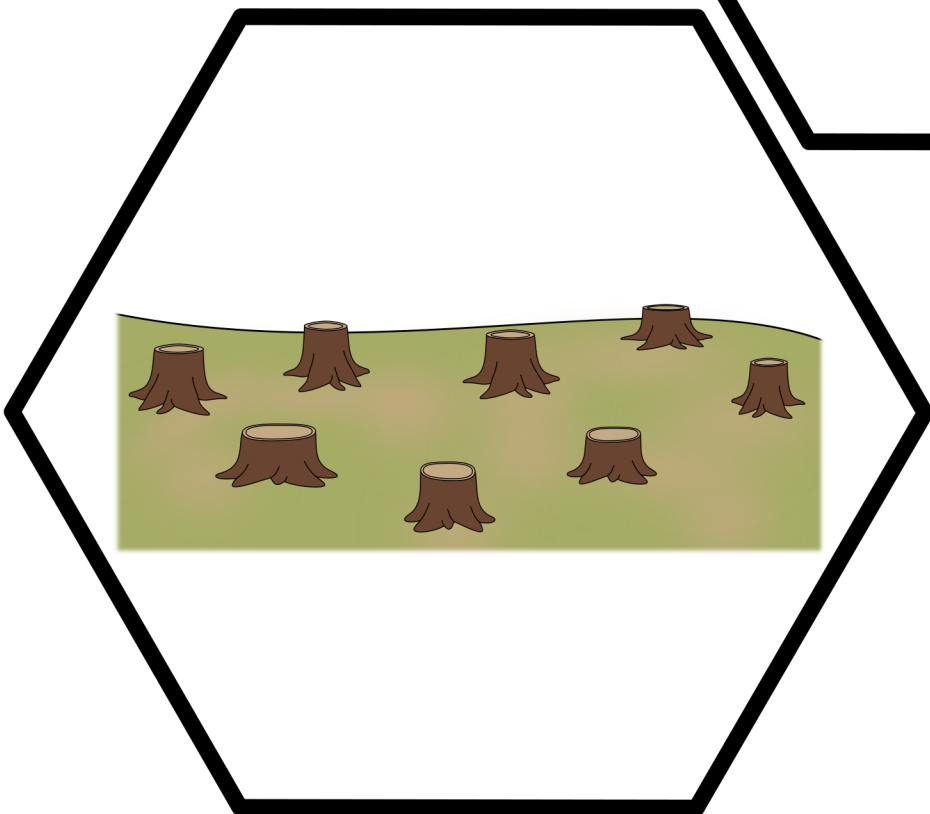
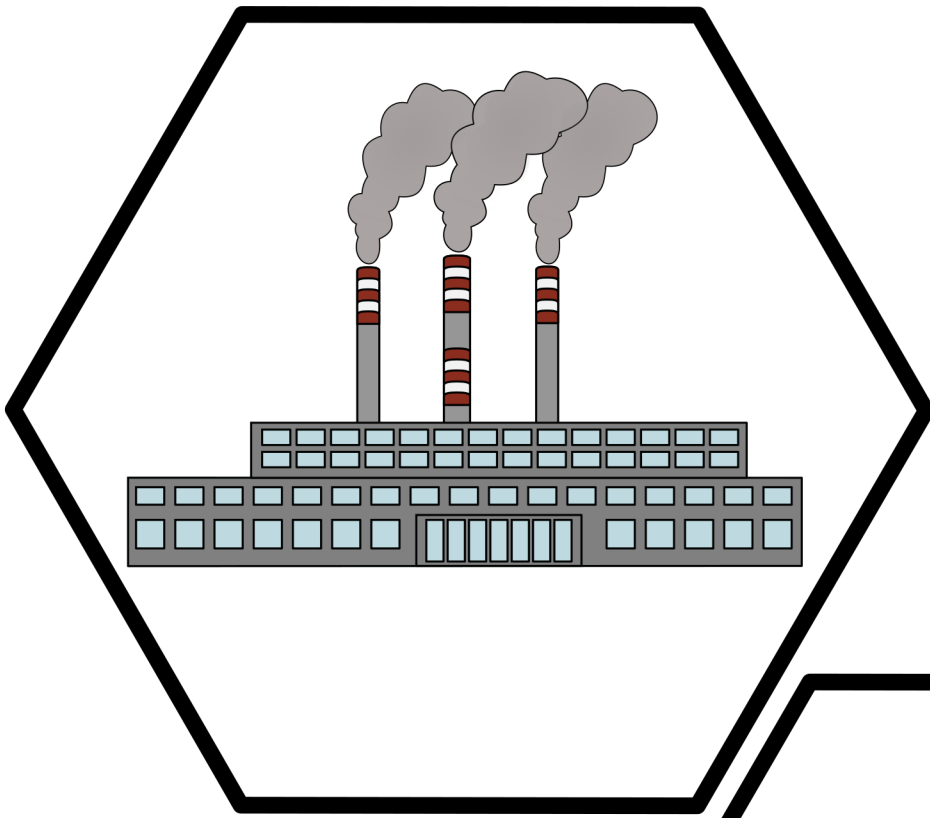

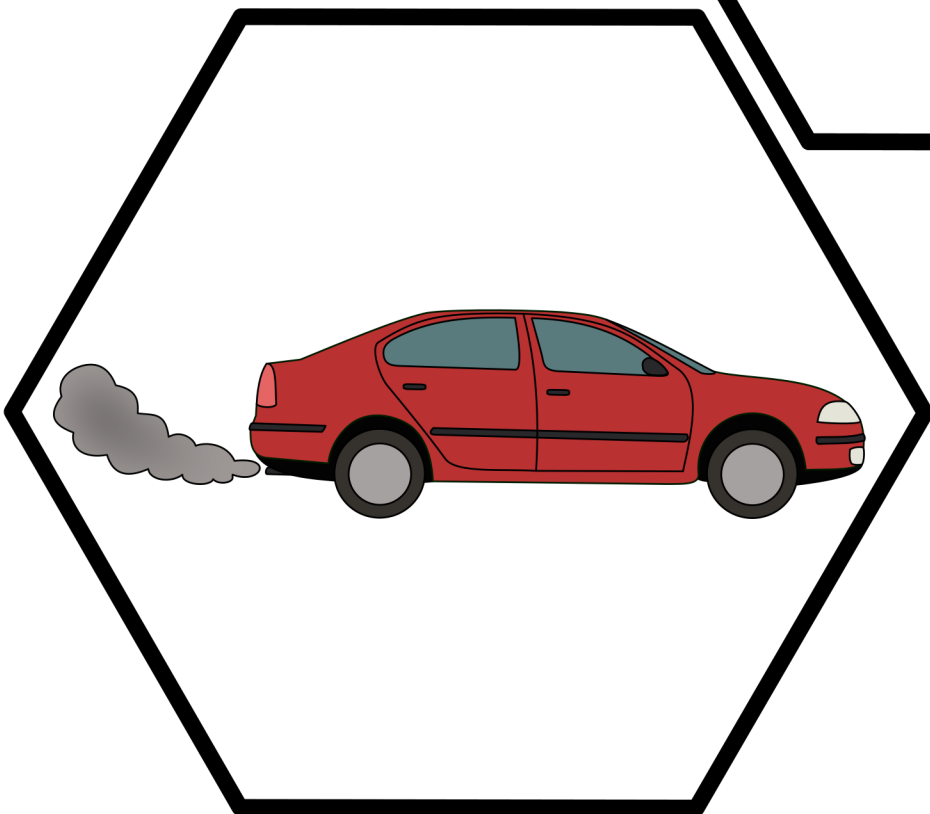
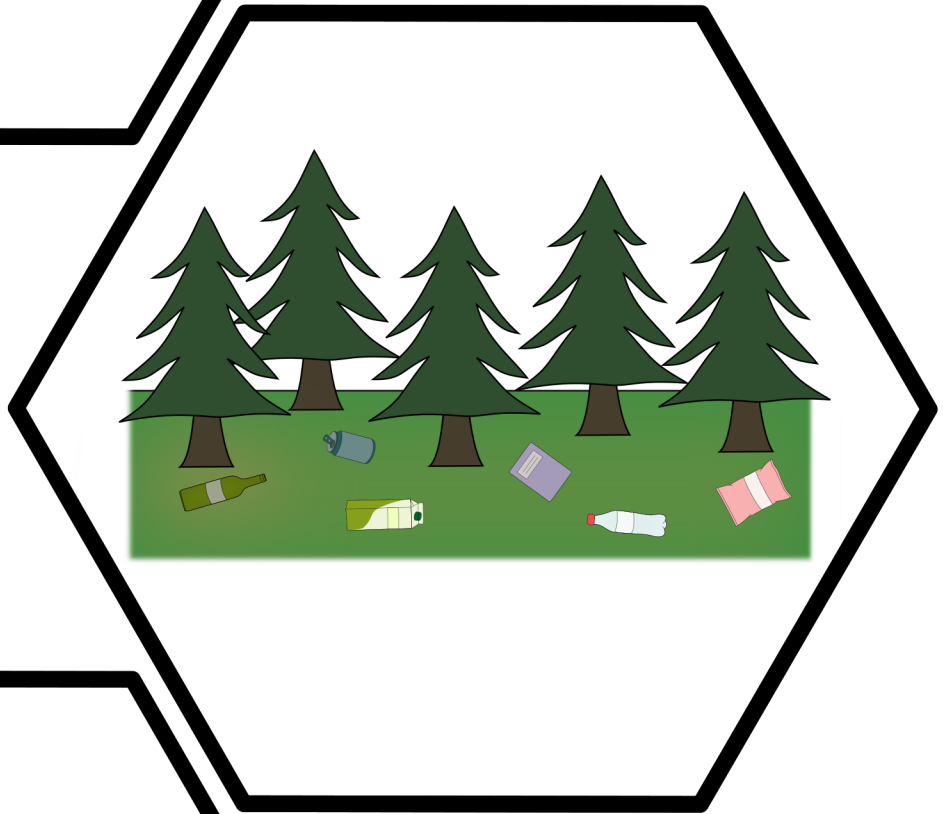
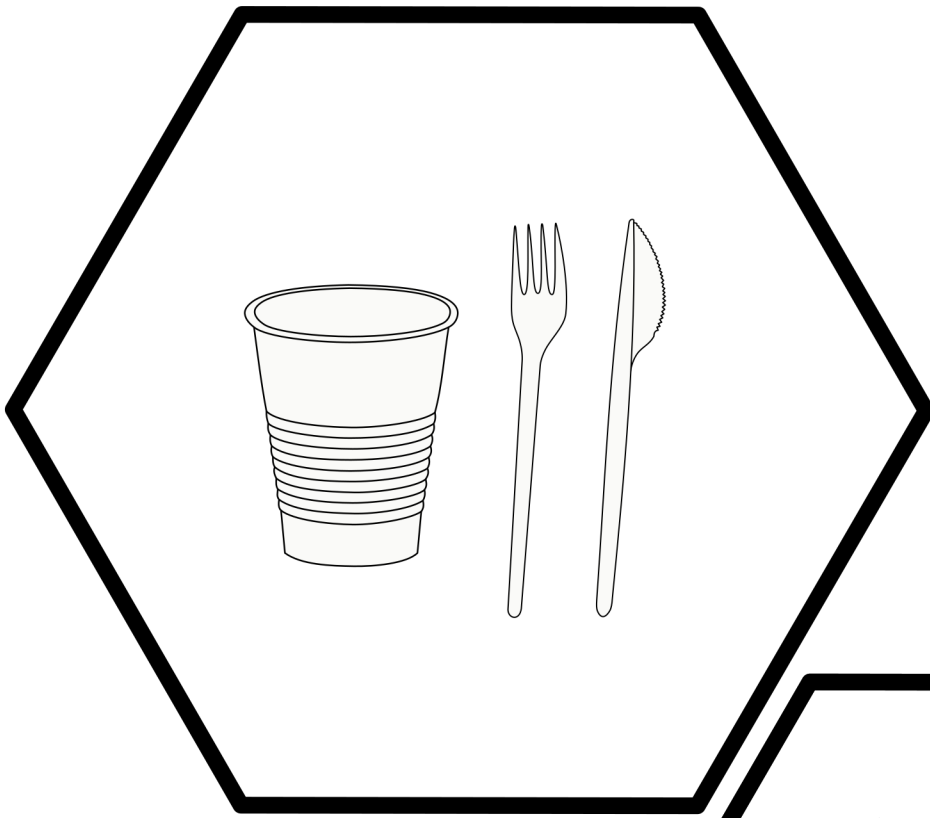

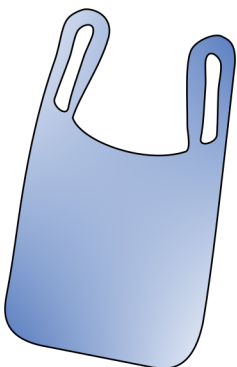
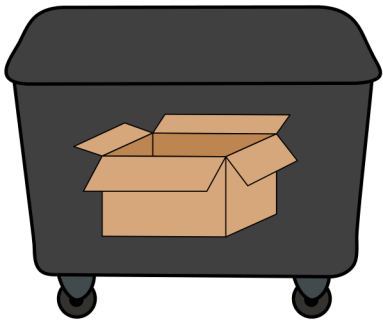
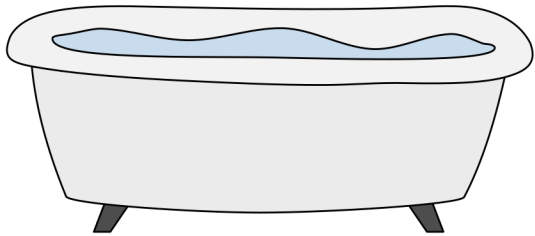
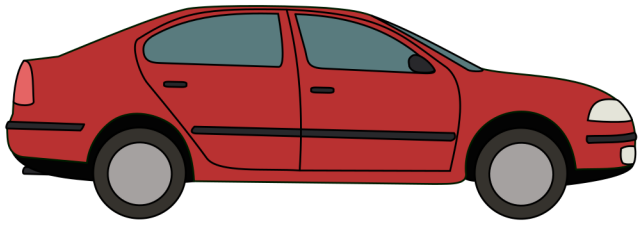

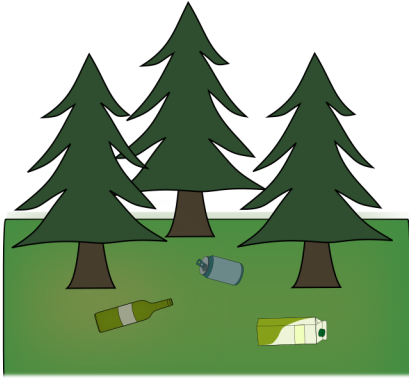

A large, empty rectangular box with rounded corners, outlined in green, intended for a label or caption.

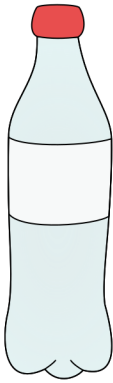

A large, empty rectangular box with rounded corners, outlined in green, intended for a label or caption.



A large, empty rectangular box with rounded corners, outlined in green, intended for a label or caption.

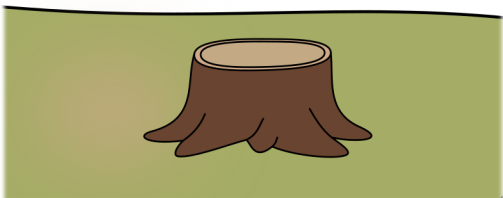

A large, empty rectangular box with rounded corners, outlined in green, intended for a label or caption.

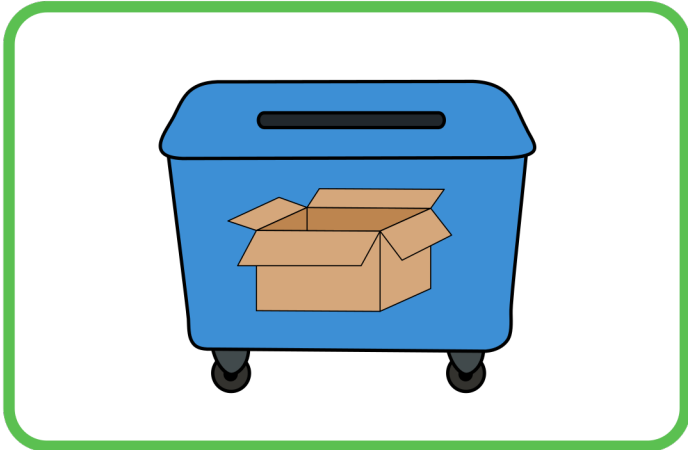

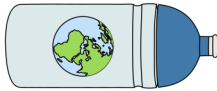
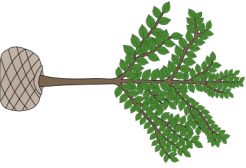
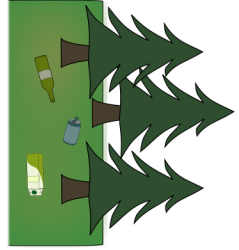
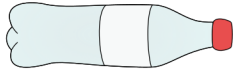
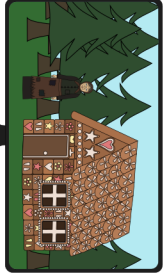
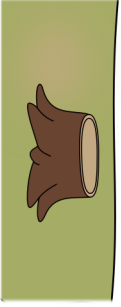
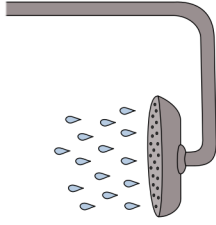
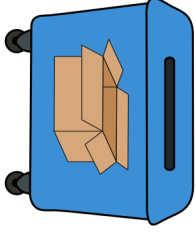
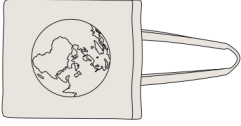
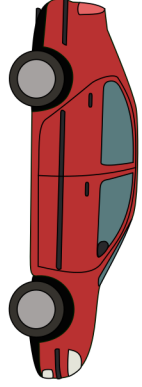
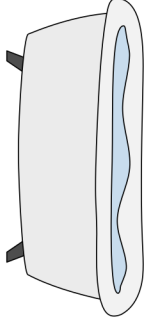
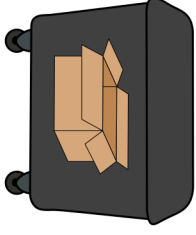
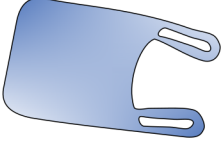

DOBA ROZKLADU  
ODPADKŮ  
V PŘÍRODĚ

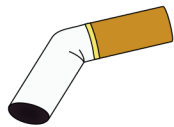
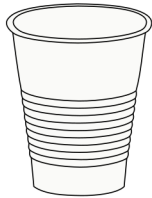

2 týdny

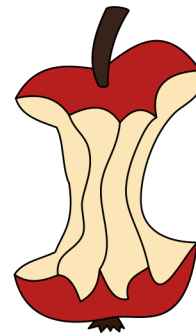

jablečný ohryzek

4 týdny

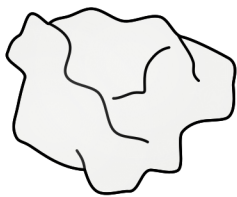

papírový kapesníček

2 měsíce

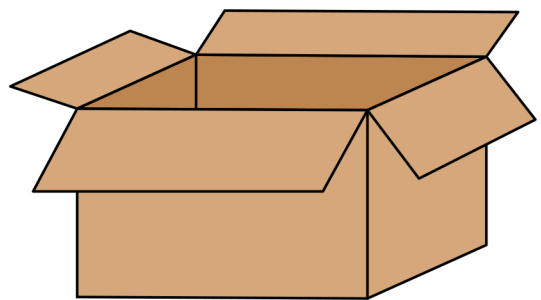

papírová krabice

4 měsíce

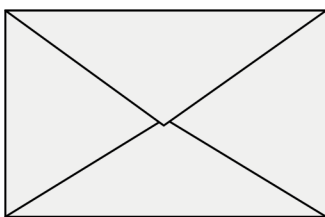

obálka

5 měsíců

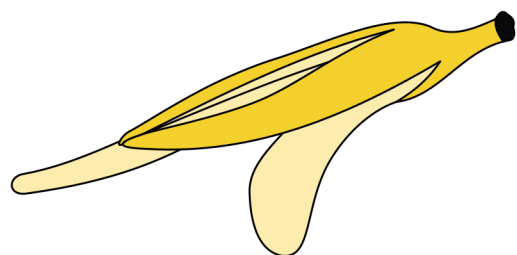

banánová slupka



1,5 roku

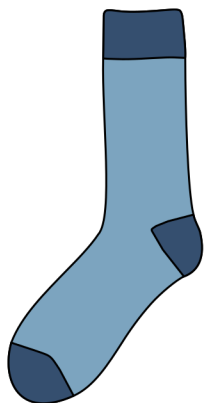

ponožka

15 let

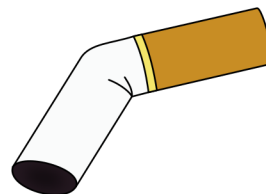

cigaretový nedopalek

15 let

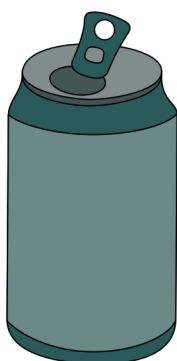

plechovka

25 let



igelitová taška

50 let



žvýkačka

70 let



plastový kelímek

100 let

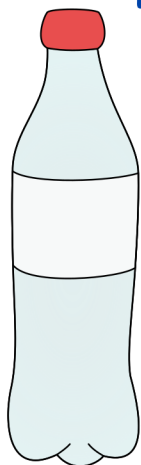

PET láhev

100 let

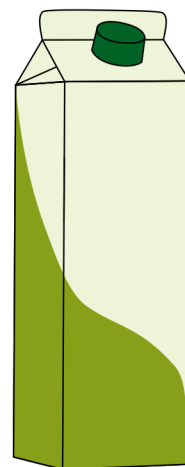

nápojový karton

250 let



jednorázová plena

přes 300 let

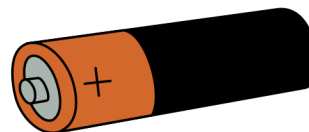

tužková baterie

přes 3000 let

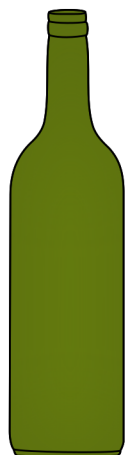

sklo

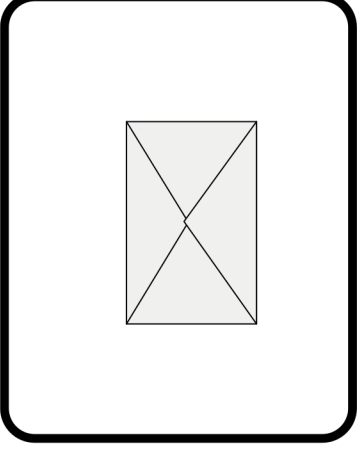
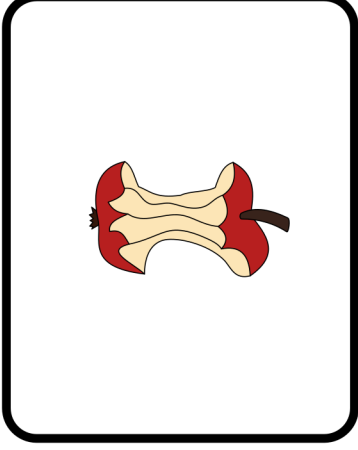
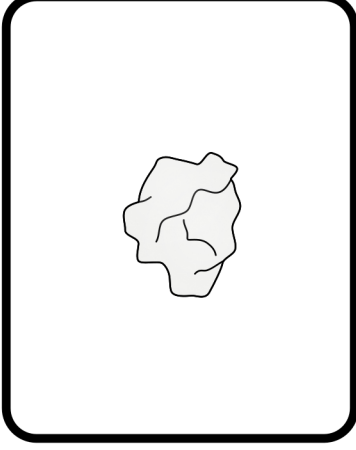
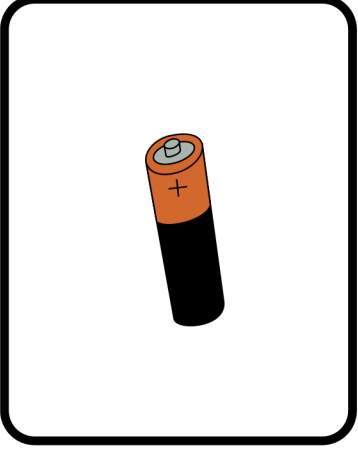
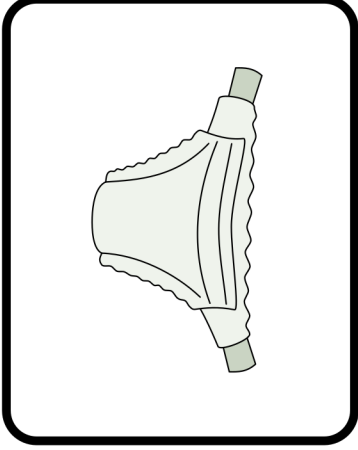
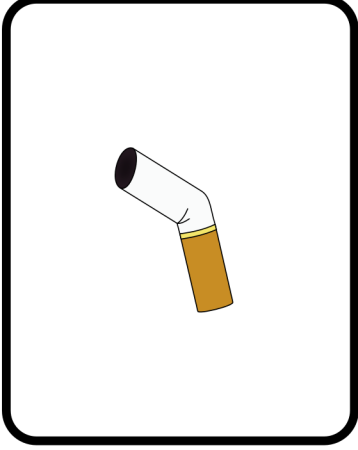
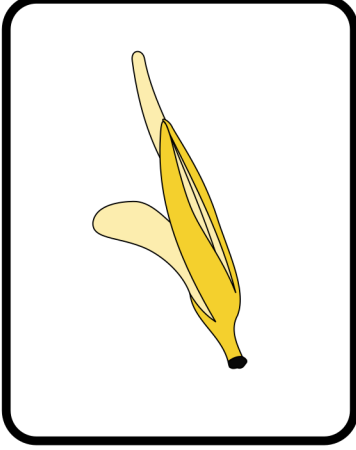
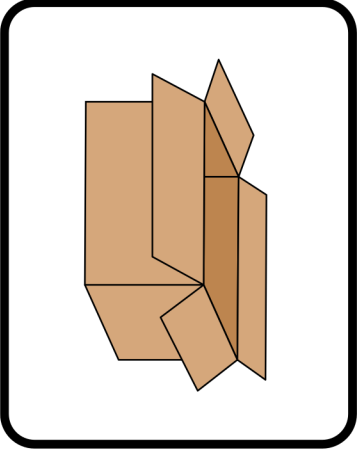
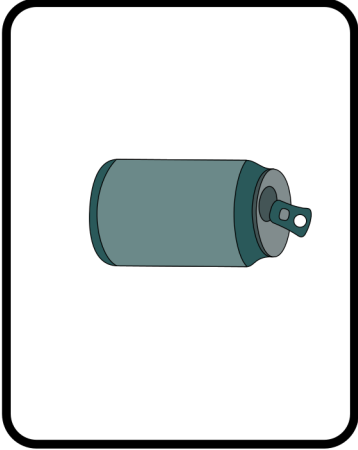
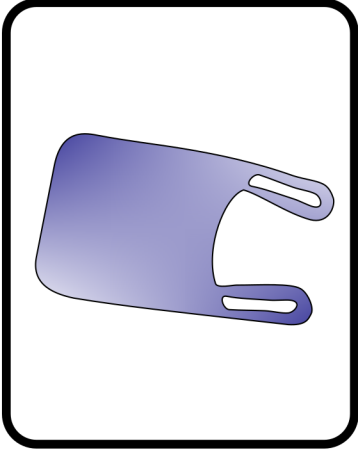
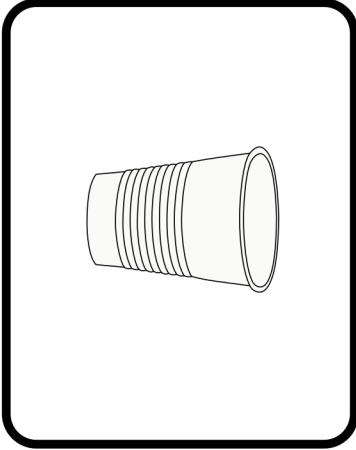
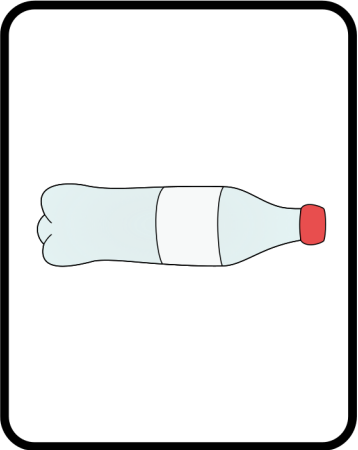
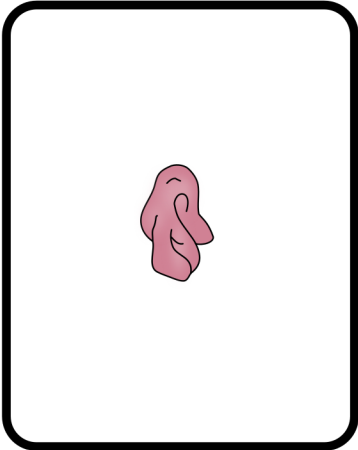
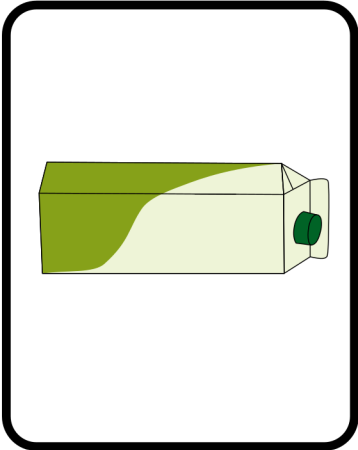
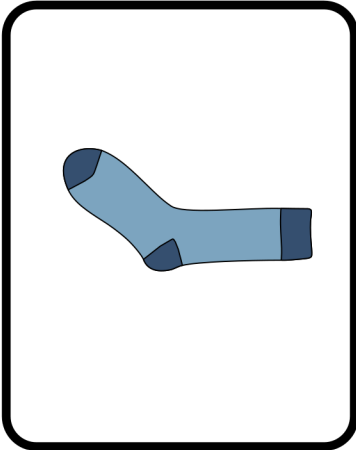

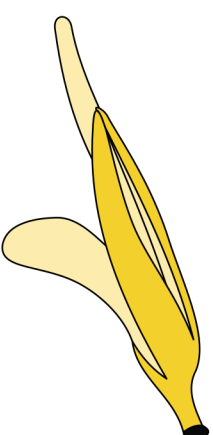
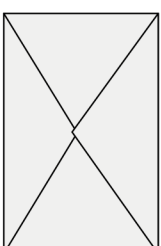
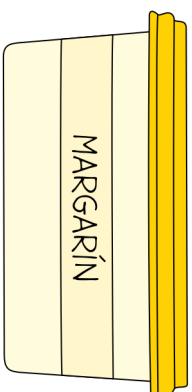
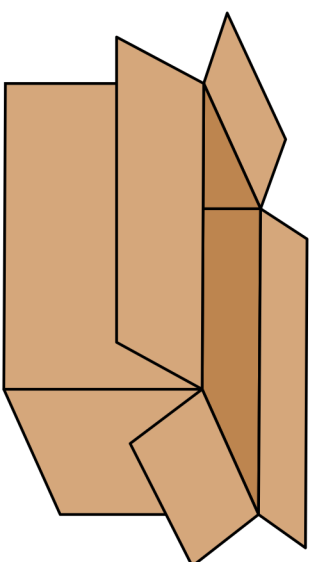
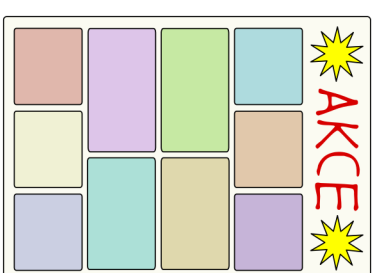
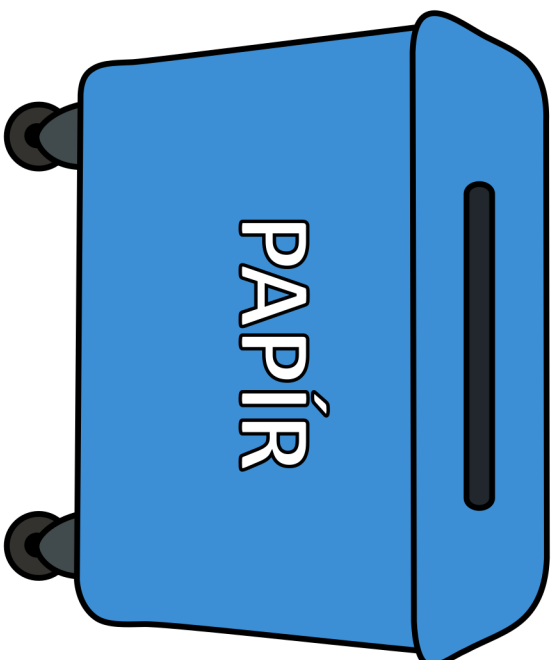
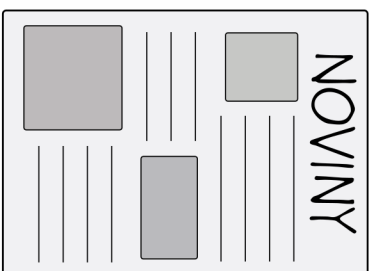
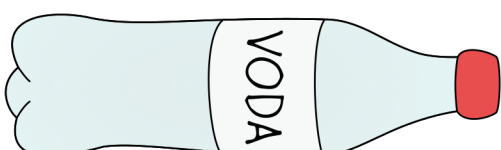
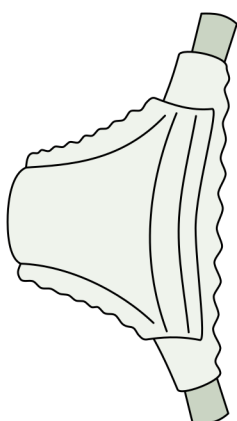
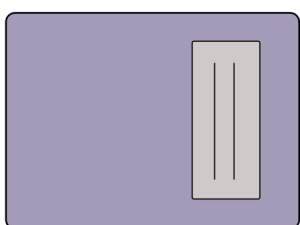

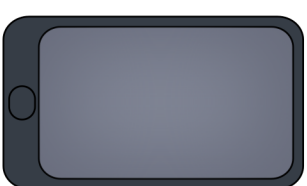
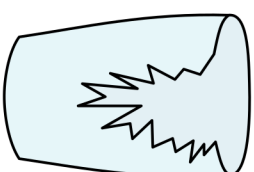
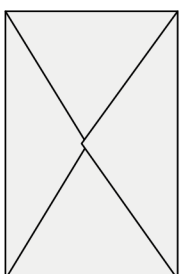
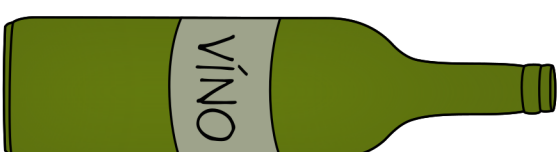
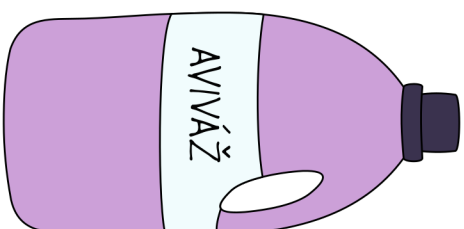
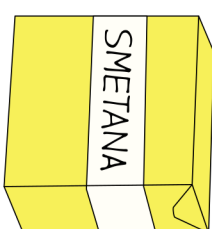
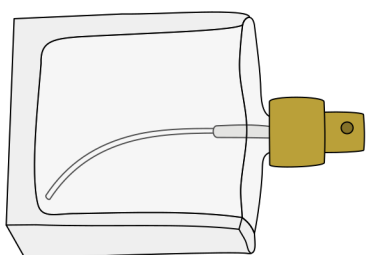
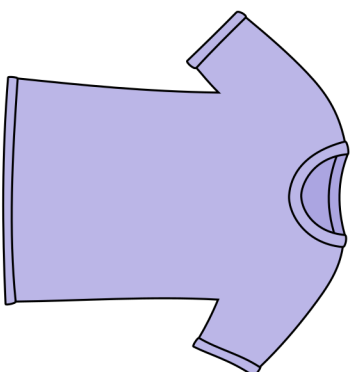
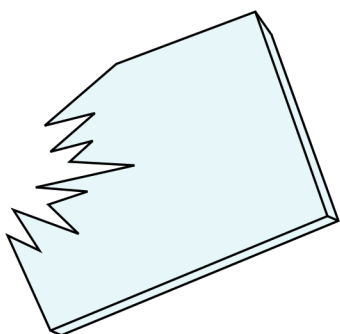

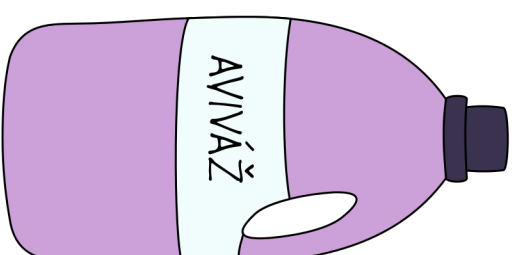
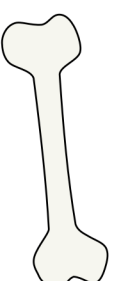
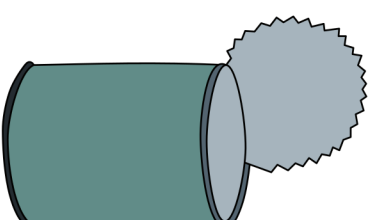
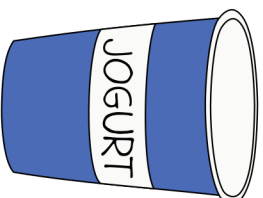
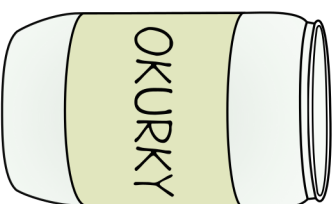
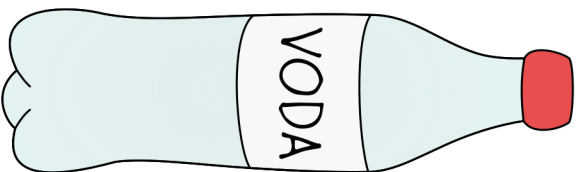
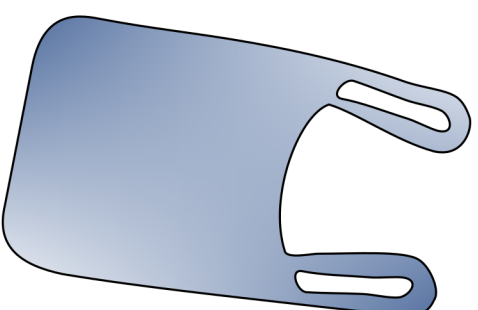
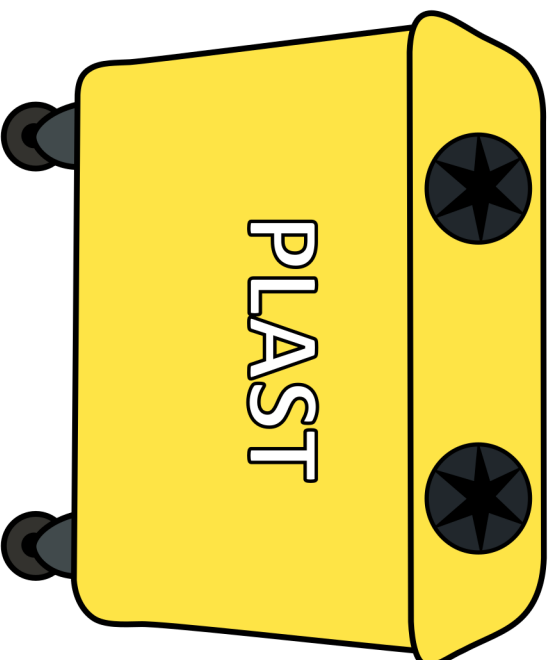
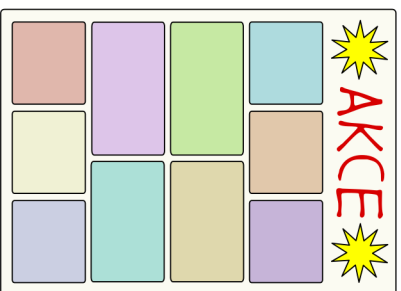
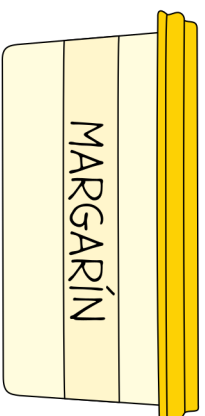
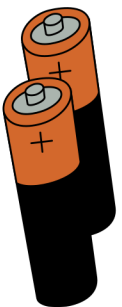

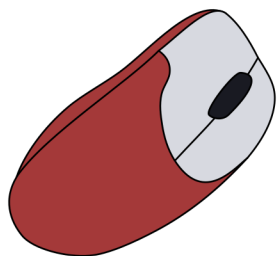
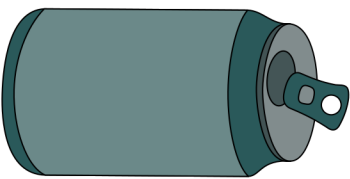
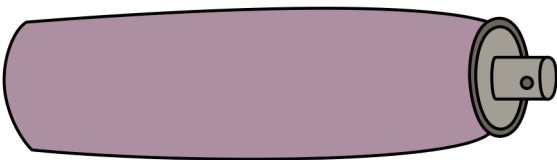
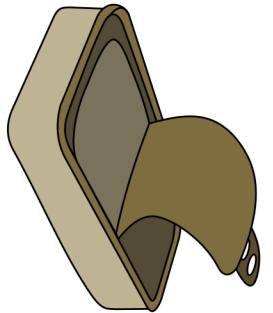
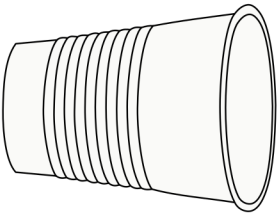
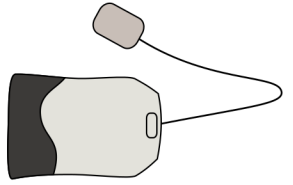
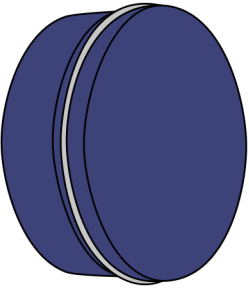
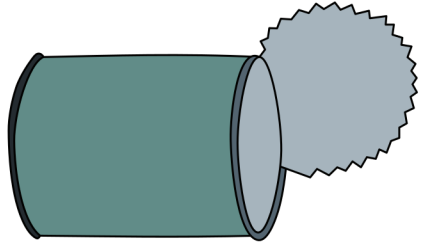
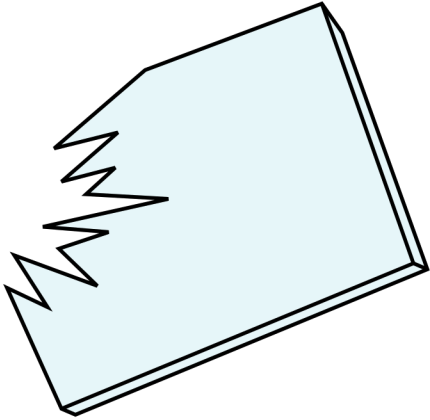

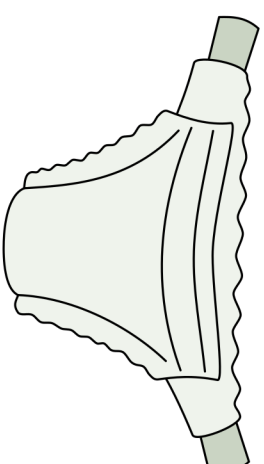
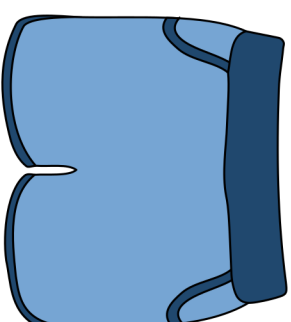
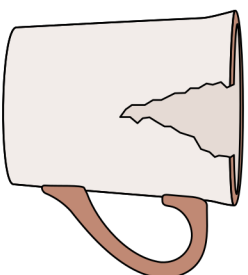
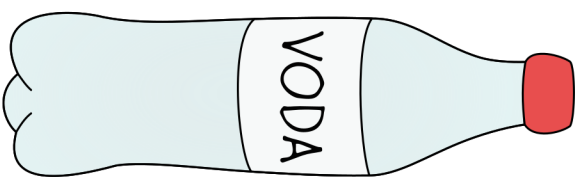
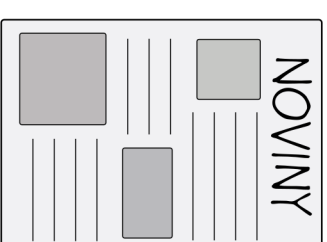
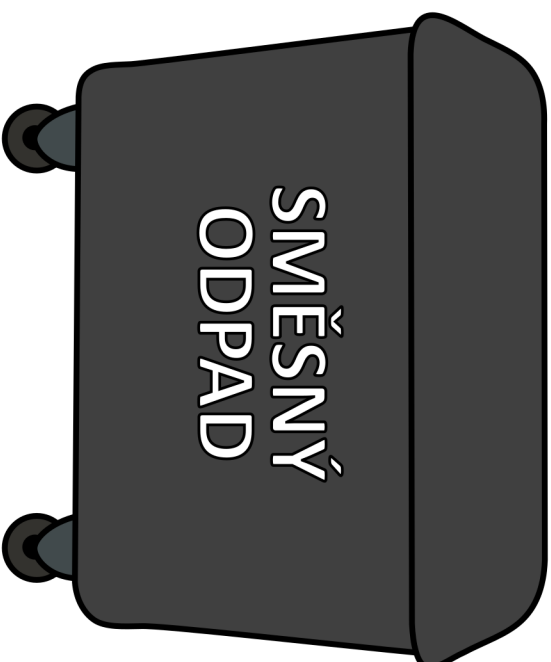
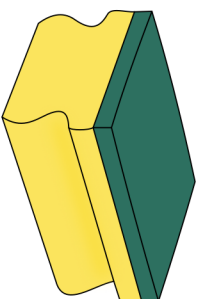
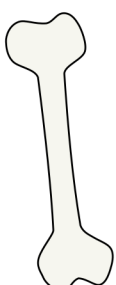
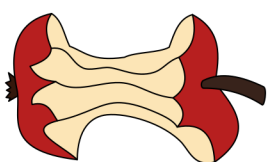
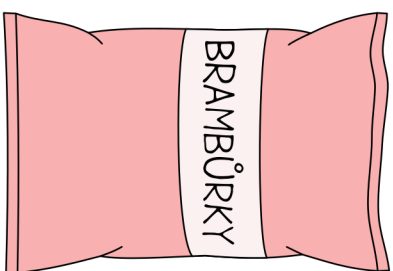



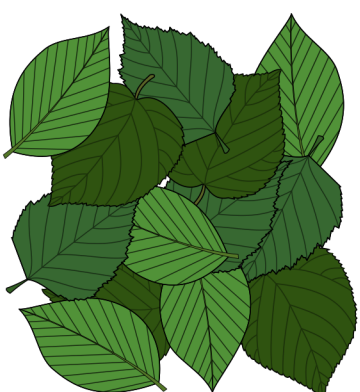
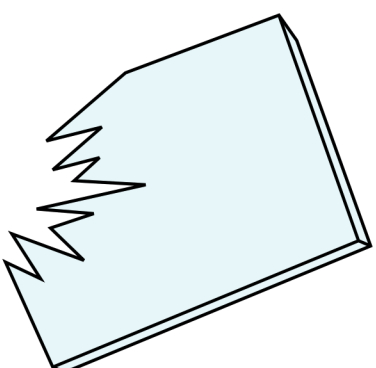
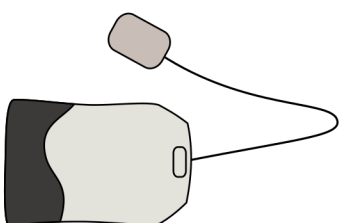
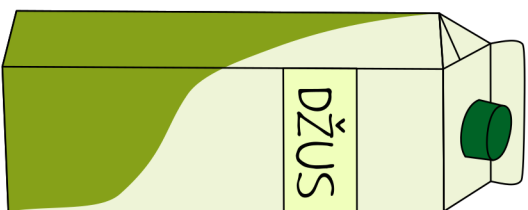
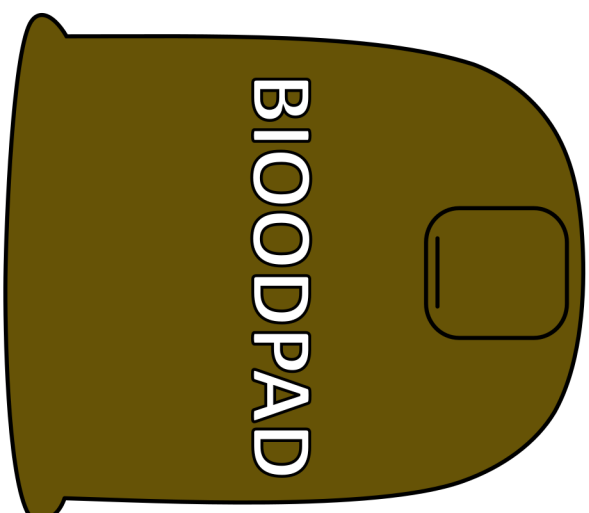
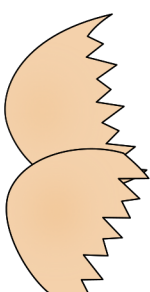
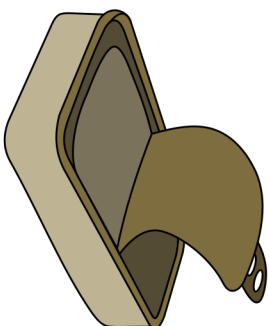
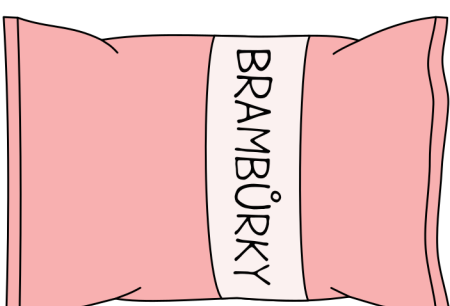
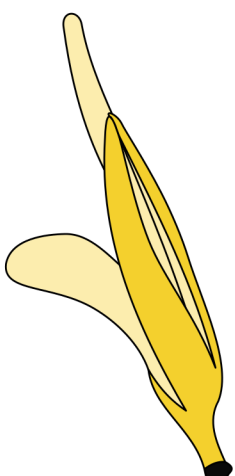
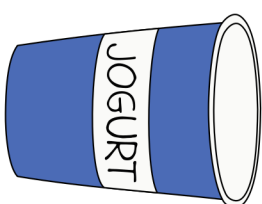
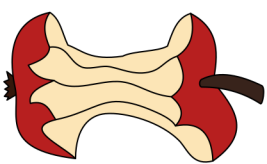

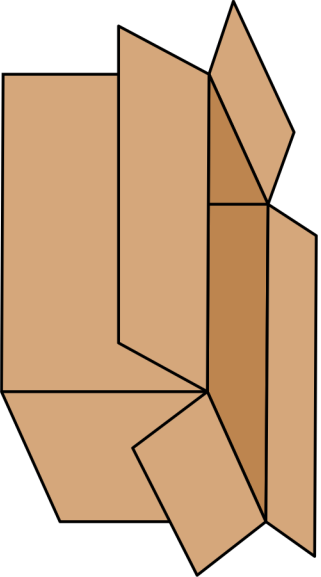
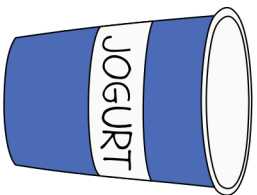
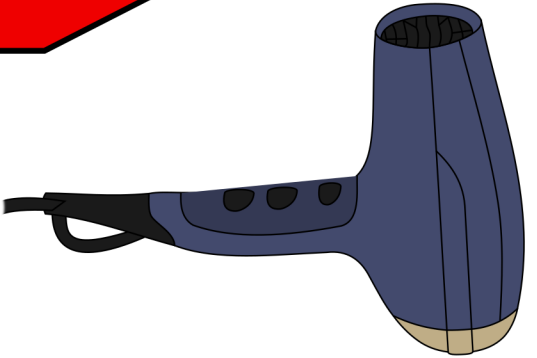
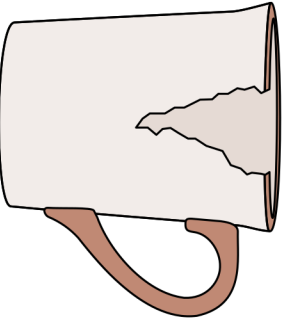
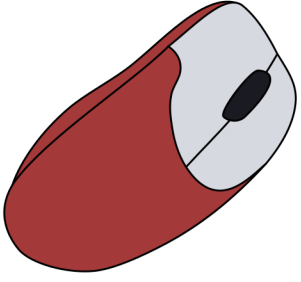
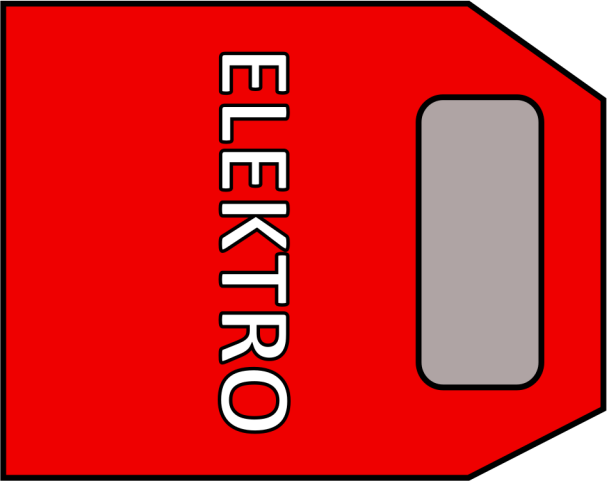
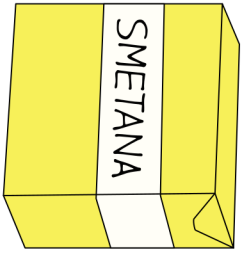
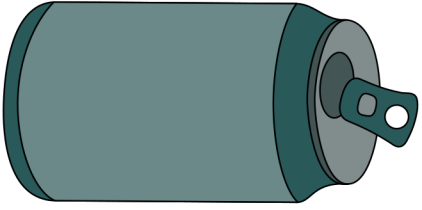
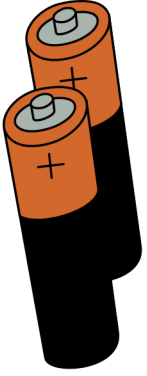
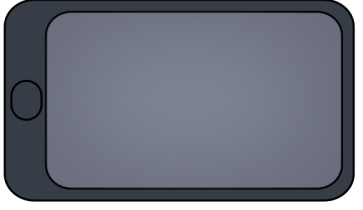

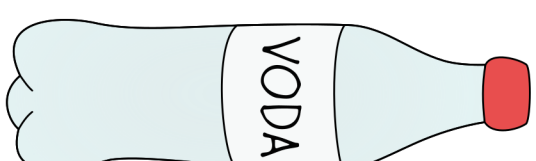
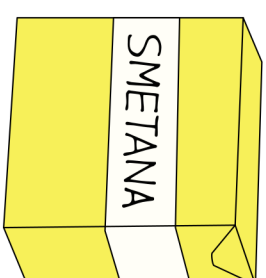
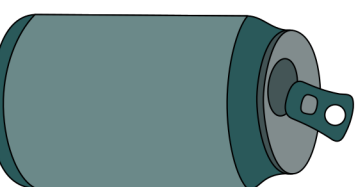
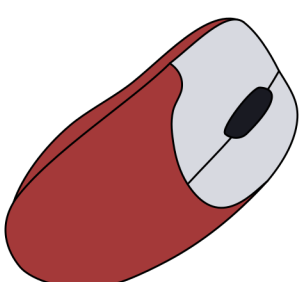
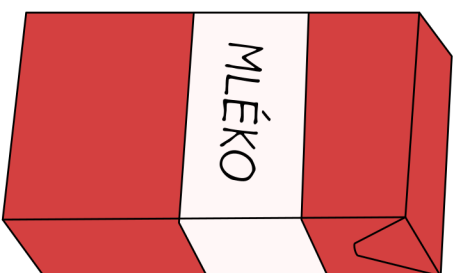
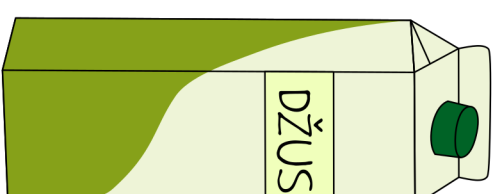
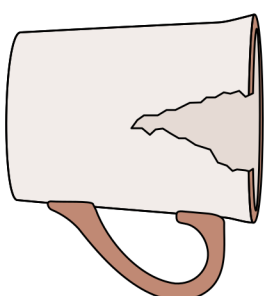
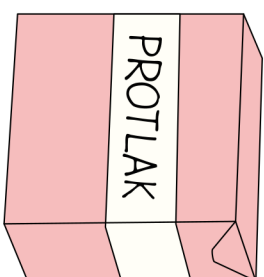
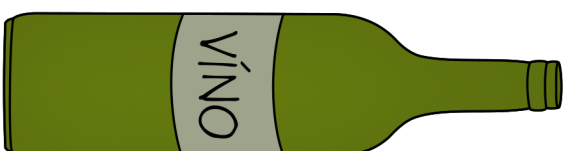
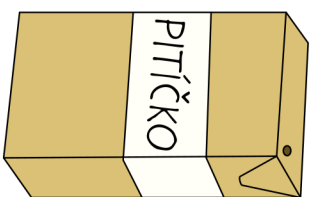

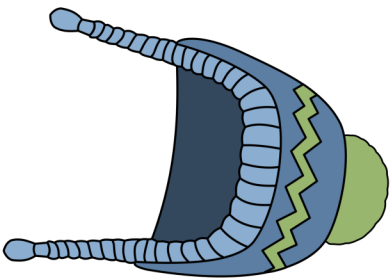
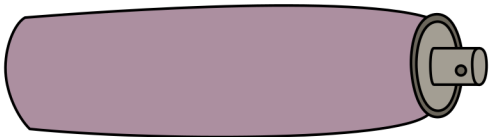
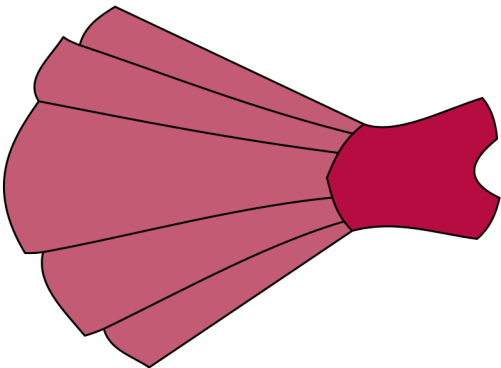
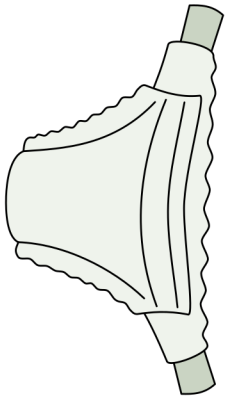
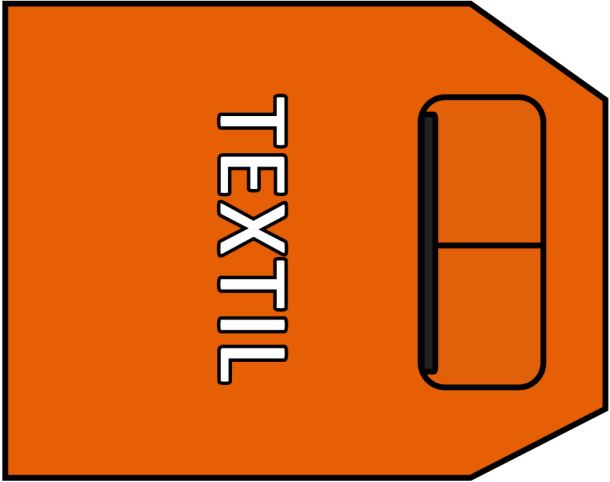
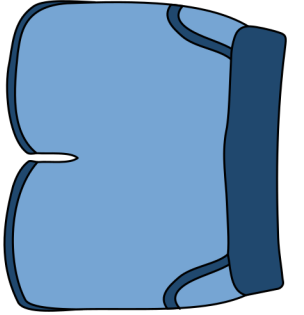
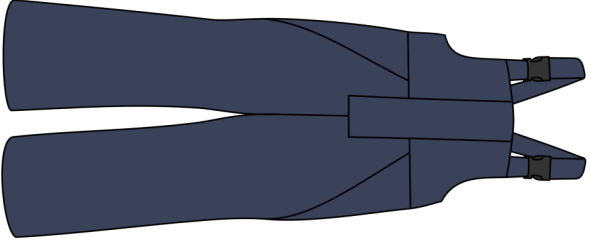
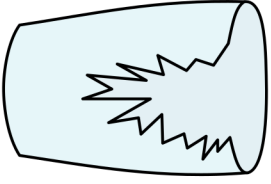
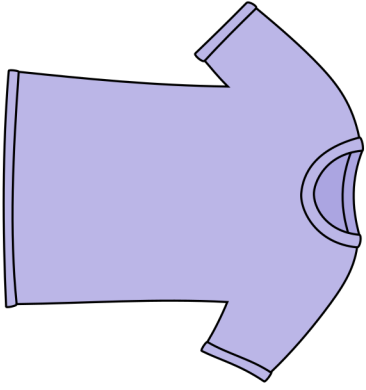
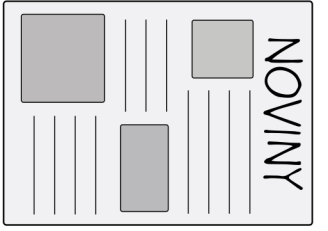

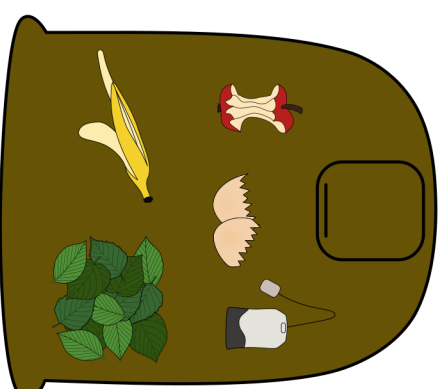
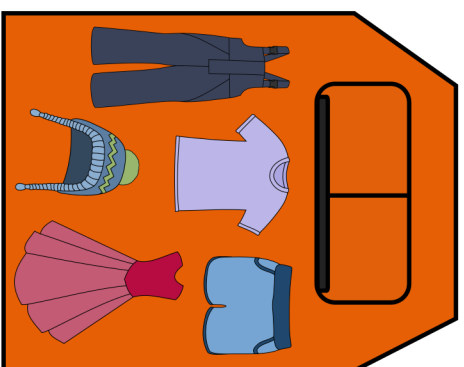
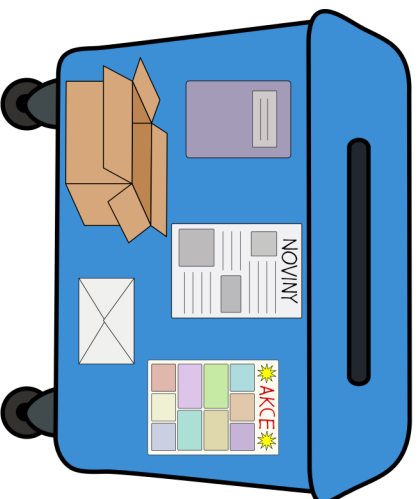
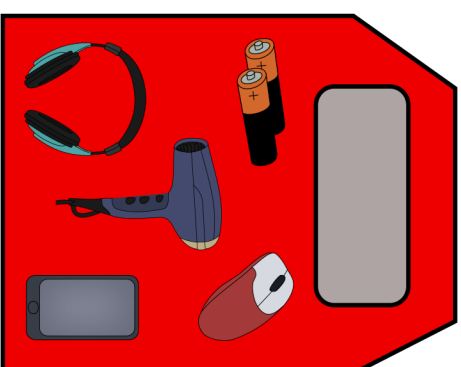
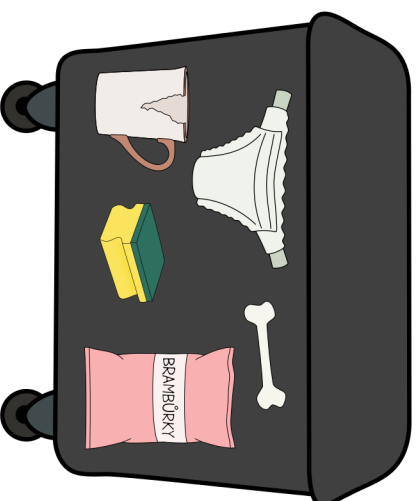
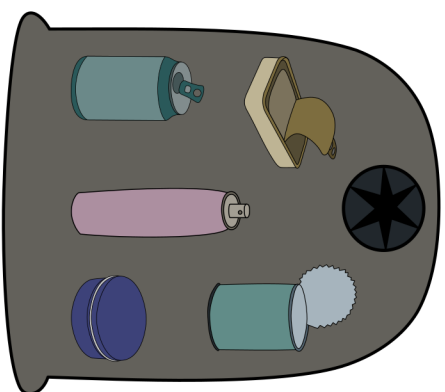
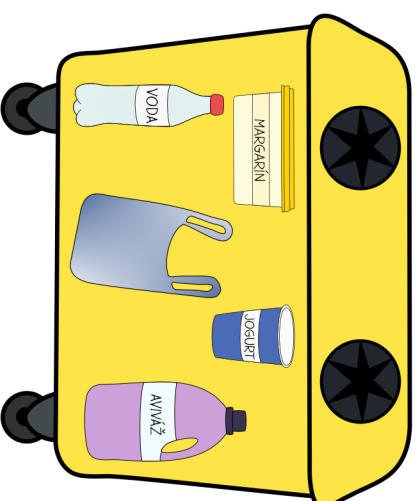
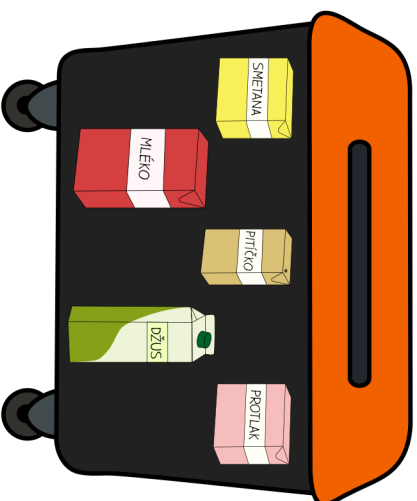

## PLASTY

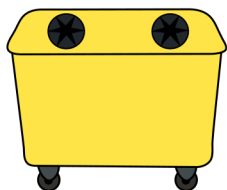

Po vytřídění dle druhů na třídící lince se nejčastěji drtí a přetvářejí na regranulát, který se přidává do nových plastových výrobků. Z PET lahví se vyrábí vlákna, která se používají jako výplň zimních bund a spacáků.

## PAPÍR

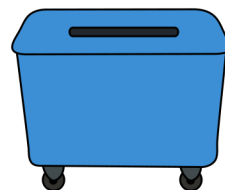

Vytříděný papír se využívá k výrobě nových papírenských výrobků, kdy polovinu směsi tvoří vlákna ze dřeva pokácených stromů a polovinu recyklovaná vlákna. Každou recyklací se papírenské vlákno zkracuje, dá se recyklovat 5 - 7krát.

## SKLO

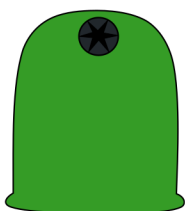

Z vytříděného skla se jeho rozmělněním vytvoří skelná drť. Ta se ve sklárnách přidává do směsi při výrobě nového skla. Nejčastěji se vyrábí lahve na nápoje.

## NÁPOJOVÉ KARTONY

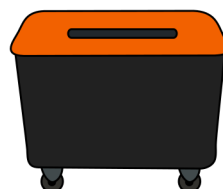

Využívají se dva způsoby zpracování. Prvním je využití v papírnách, neboť z velké části obsahují papírenské vlákno. Druhou možností je výroba stavebních a izolačních desek.

## BIOODPAD

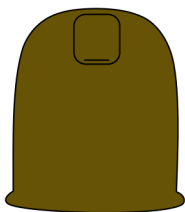

Zpracovává se v kompostárnách, kde se v drtičce nadrtí a poté je uložen na hromadu, která se pravidelně překopává. Přibližně za 3 měsíce je hotový kompost, který se přidává do záhonů.

## KOVOVÉ OBALY

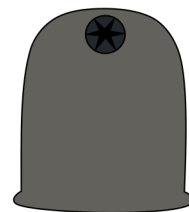

Obaly se roztřídí a dále se zpracovávají v hutích, kde se přidávají k surovinám na výrobu kovů. Následně se roztaví a vyrábí se nové kovové výrobky. Hliníkové plechovky jsou z velké části z recyklovaného hliníku.

